



# CITY SHAPER<sup>SM</sup>

## Challenge Updates

---

**Week of 25 November 2019**

**Innovation Project Updates – 0**  
**Robot Game Updates – 2**

### Robot Game Updates

(RG22 has graphics added. The addition doesn't change anything.)

#### **RG26 - EFFICIENT AND EFFECTIVE GAME SUPPORT**

Robot Game Support is only able to provide fast and reliable answers to direct questions which are focused on particular text or graphics from the Field Setup, Missions, Rules, or these Updates.

The more a team's email is focused on descriptions, pictures, or videos of someone's Field, or event, or something they saw or heard, the slower and less reliable our answer is likely to be. In fact, it is usually inappropriate or even impossible for us to try to:

- study or interpret stories, photos, attachments, or links in emails from teams
- score situations we did not or can not see in person
- explain or second guess decisions other people made, after the fact, when we weren't there

We respond to all emails, but your understanding and cooperation here will help everyone.

#### **RG25 - M12 STABILIZERS**

Be sure **all forms** of Equipment are no longer touching any of your M12 Stacks at the end of the Match...

- M12 says Stacks need to be Independent for their HEIGHT / Levels to score.
  - Rule 33 defines "Independent" as not touching any Equipment.
  - Rule 2 makes it clear that frames for stabilizing your M12 Stacks are Equipment.
- If this is a surprise to you, have a fresh look at the other Missions to see where else the word "Independent" is important.

---

**Week of 18 November 2019**

**Innovation Project Updates – 0**  
**Robot Game Updates – 2**

### Robot Game Updates

#### **RG24 - ARCHITECTURE EQUIPMENT WARNING**

Be sure your M11 Structure is not touching any of your M12 Stacks at the end of the Match...

---M12 says Stacks need to be Independent for their HEIGHT / Levels to score.

---Rule 33 defines "Independent" as not touching any Equipment.

---Rule 2 and Update 18 make it clear that your M11 Structure is Equipment.

## RG23 - REMINDER NOTES

You can bring notes to the Match, on one sheet of paper, to remind you of Robot position and program specifics. Maximum paper size is 9 in. by 12 in. (229 mm by 305 mm) - "Letter" and "A4" both qualify. The paper can have no other purpose, and will not count as Equipment.

---

## Week of 11 November 2019

Innovation Project Updates – 0  
Robot Game Updates – 1

### Robot Game Update

## RG22 - HOME SAFETY

Be sure you know Rule 27. Interrupting the Robot even partly in the Launch Area can cause you to lose a Precision Token. To avoid losing a Token, Interrupt the Robot completely in Home only.

(Experienced teams are not experienced with this year's Rules. The Launch Area is not the same as "BASE" from past years.)

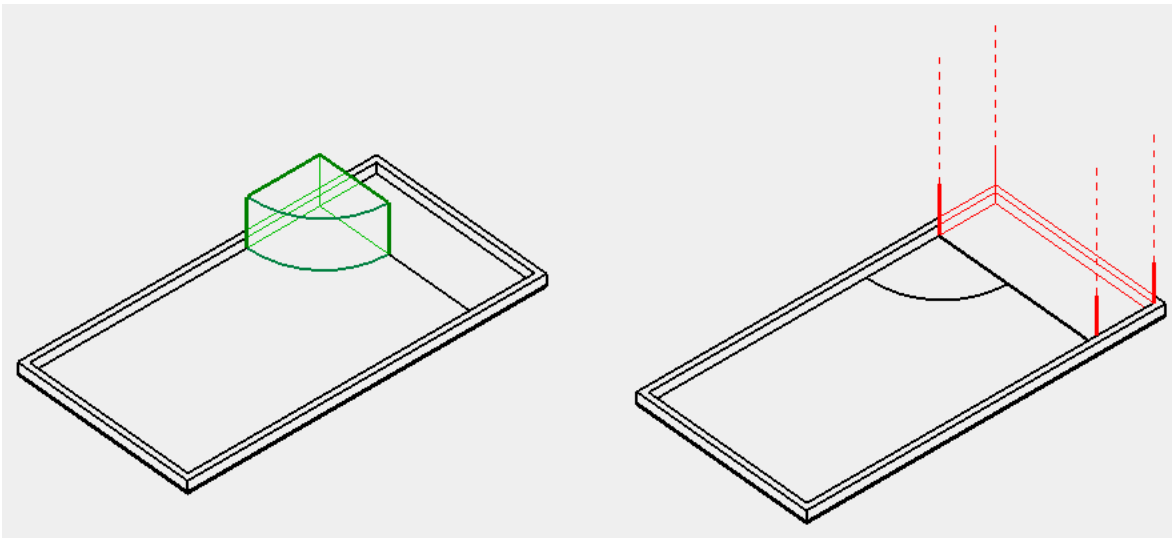

All mention of the "Launch Area"  
means here and only here, especially  
Rule 21

**"Leave from here"**

All mention of the "Home"  
means here and only here, especially  
Rule 27

**"Return to here"**

---

## Week of 21 October 2019

Innovation Project Updates – 0  
Robot Game Updates – 1

## Robot Game Update

### RG21 - ALLOWABLE JIG USE

A careful read of the Rules reveals these two facts about the use of frames (“jigs”) for Robot Launch alignment.

---**You** are not allowed to be touching any jig at the time of a Launch.

---The **Robot** is not allowed to be touching a jig at the time of a Launch, **unless** the jig is completely in the Launch Area.

This means there are two allowable ways to use a jig:

---For any jig >> Align the Robot against the jig, pull the jig completely into Home, then Launch.

(If you just want to use the jig to AIM the Robot, this is the recommended way.)

---Only for jigs which fit and stay completely in the Launch Area >> Align the Robot against the jig, let go of the jig, then Launch, **leaving the jig as is, untouched** until the next Robot Interruption.

(If you want to use the jig to aim AND GUIDE the Robot, this is the required way.)

---

## Week of 7 October 2019

Innovation Project Updates – 0  
Robot Game Updates – 7

## Robot Game Updates

### RG20 - COMPLETE BRIDGE SHIPMENT

Your complete/correct Bridge Mission Model includes two top halves with Flags, but only ONE ramp side, as shown below. That is all you need to practice, since the Robot has no reason to drive past the Flags. The only time a second ramp is attached to the far side is for the other team, at a competition.



### RG19 - LEAVING THE FLAG

There is no exception to Rule 35 in Mission 1, so Bridge and Flag scoring conditions need to be visible to the referee as the Match ends.

### RG18 - M11 STRUCTURE CATEGORY

The M11 Structure is Equipment. It can seem like a Mission Model, and on some pages outside the Robot Game text it's even implied to be one, but by Rules 2 and 5, and this Update, it is Equipment.

## RG17 - PARTLY IN / COMPLETELY IN

For M12 and M13, look at the whole Stack, not just Level 1, to decide if it is "in." A Stack is

--in (partly in) a Circle if ANY bit of the Stack is in the space above the Circle's interior or line.

--Completely In a Circle if EVERY bit of the Stack is in the space above the Circle's interior or line.

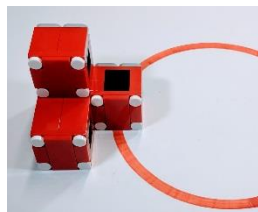

Partly In.  
10 points shown.

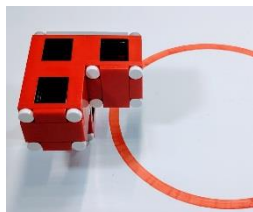

Partly In.  
10 points shown.

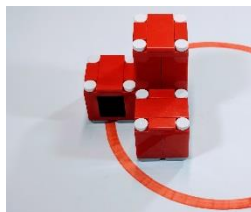

Partly In.  
10 points shown.

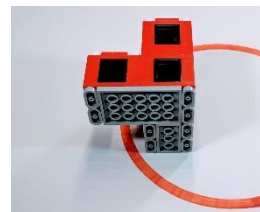

Partly In.  
10 points shown.



Partly In (Benefit Of The Doubt).  
10 points shown.



Completely In.  
20 points shown.  
(Includes Circle Color Match.)



Completely In (Benefit Of The Doubt).  
20 points shown.  
(Includes Circle Color Match.)

## RG16 - BRIDGED, EXAMPLES

Notice how Bridging to a Circle can affect Height Score.

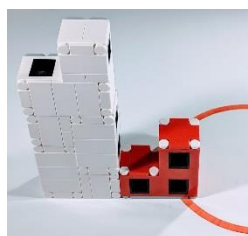

Two Stacks.  
10 points shown.  
(Not Bridged.)

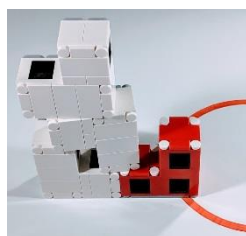

One Stack.  
25 points shown.  
(Bridged.)

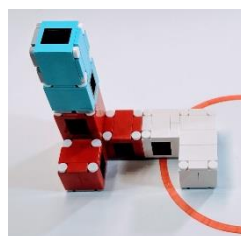

Two Stacks.  
5 points shown.  
(Not Bridged.)

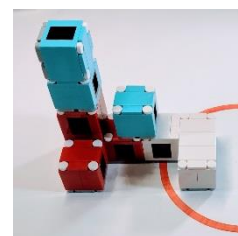

One Stack.  
20 points shown.  
(Bridged.)

## RG15 - "BRIDGED" STACK COMBINATIONS

Stacks touching only each other's sides are separate. But if one Unit touches Flat Down on multiple Stacks, they are "Bridged" and all count as one Stack. Notice how Bridging Completely In a Circle can affect Height score.

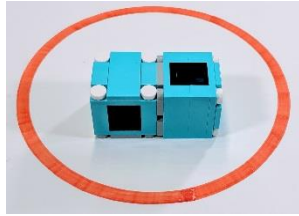

Two Stacks.  
10 points shown.

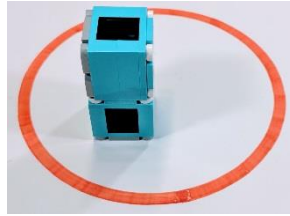

One Stack.  
10 points shown.

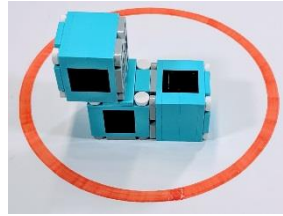

Two Stacks.  
15 points shown.  
(Not "Bridged.")

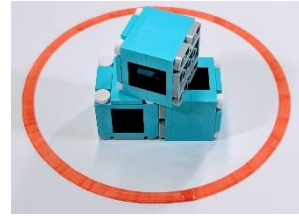

One Stack.  
10 points shown.  
("Bridged.")

## RG14 - BUILDING UNITS, GENERAL

---A Building Unit is the whole Model, not the individual rooms (left picture).

---It's not required for windows to face sides, or gray bases to face the Mat (center picture).

---Stacked Building Units require surface-to-surface contact, like floors and ceilings (right picture).



This is 1 Building Unit, not 4.  
10 points shown.



This scores as a Stack.  
5 points shown.

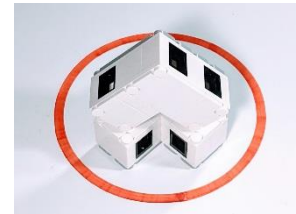

This top Unit doesn't count.  
5 points shown.

(RG11 was removed, as referees did not find it useful. The removal does not change anything.)

## Week of 16 September 2019

Innovation Project Updates – 0  
Robot Game Updates – 1

### Robot Game Update

## RG13 - HOME, STRATEGIC AND ADAPTIVE STORAGE

With the implied permission from Rule 22, and clarification here, things completely in Home can be stored, handled, and shifted around any way you like, any time after inspection.

---If the Robot happens to interact with something which is at rest in Home, that shall not be considered an interaction with you, so it's not an Interruption. Said another way: After any Launch, and before the next Interruption, the Robot is free to go in and out of Home, and interact with things, even if you "staged" them strategically.

---If the Robot is on the way Home and you think its entry will be blocked by something in Home, you can shift that thing out of the way, as long as it was and remains completely in Home the whole time.

Reminder: The Launch Area is not part of Home. You can not touch anything in the Launch Area between a Launch and the next Interruption, except to remove a Stranded Object as allowed in RG09.

## Week of 26 August 2019

Innovation Project Updates – 0  
Robot Game Updates – 3

### Robot Game Updates

#### RG12 - BRIDGE BARRIERS NOT ALLOWED

The only way Robot X can stop Robot Y from scoring Flag points is to be faster or stronger at scoring Flag points. Robot clashes are expressly allowed in the text of Mission 1 by Rule 30's first sentence, but all other competitive action is governed by Rule 30's second sentence.

(RG11 was removed, as referees did not find it useful. The removal does not change anything.)

#### RG10 - BOXES AND TRAYS

- You can carry your Equipment to the Field in any box or tray.
- When you get to the Field, place all your Equipment in one of the Inspection Areas and store the box/tray as directed by the Referee.
- After Inspection, all your Equipment is stored in Home, as directed by Rule 19.

---

## Week of 19 August 2019

Innovation Project Updates – 0  
Robot Game Updates – 1

### Robot Game Update

(Update RG02 was clarified)

---

## Week of 12 August 2019

Innovation Project Updates – 0  
Robot Game Updates – 6

### Robot Game Updates

#### RG09 - LAUNCH AREA STRANDING

Things Stranded partly or completely in the Launch Area \*can be taken into Home if you wish. If that action clearly/directly produces a scoring condition, the score won't count.

\*This exception to Rules 22 and 29 does not apply if the Stranded thing reaches out of the white/logo arc area.

#### RG08 - HAND USE FOR INSPECTION

Your hands can be used to restrain/confine Equipment within the volume of an Inspection Area.

## RG07 - MIS-LAUNCH

If you Interrupt the Robot so soon after Launch that it hasn't yet reached a Launch Area perimeter line, you will need to re-Launch, but you will not lose a Precision Token. This is an exception to Rule 27.

## RG06 - STRATEGIC/PRECISION STOP

If a new scoring condition is produced by the strategic timing of an Interruption (your eyes did the work of a timer or sensor), and this is obvious to the referee, Missions benefitting will not score.

## RG05 - RULE 28 CLARIFIED

Here are the three possibilities and their outcomes:

- 1 - If the Cargo came with the Robot from the latest Launch: You get the Cargo back.
- 2 - If the Cargo was Completely in Home when the Robot was Interrupted: You get the Cargo back.
- 3 - Otherwise: The Referee takes the Cargo.

---

### Week of 4 August 2019

Innovation Project Updates – 0  
Robot Game Updates – 1

#### Robot Game Update

(Update RG01 was revised)

---

### Week of 28 July 2019

Innovation Project Updates – 2  
Robot Game Updates – 4

#### Innovation Project Updates

##### IP02 - MISSION 11 AND THE (MOSTLY) WHITE BRICKS

In your CITY SHAPER<sup>SM</sup> challenge set, you will find LEGO elements in the bags labelled “10” to make a team-designed model for robot game Mission 11. **The model can be of any design if it meets the requirements of Mission 11.** This model is supposed to represent your team's Innovation Project in some way, but you will not be *required* to explain your model's design or discuss your Project during your robot game matches. (You may *want* to share this information with others – and that's fine – but it's not required.) Please see the robot game missions, rules and updates for more information about Mission 11.

##### IP01 - YOUR COMMUNITY

The Innovation Project problem statement instructs teams to:

- Identify a problem with a building or public space in your community.
- Design a solution.
- Share your solution with others and then refine it.

For this year's project, your team is free to define "your community" in the way that works best for you. This means your team could look at a problem in your local town or city, your country, or even in another part of the world.

## Robot Game Updates

### RG04 - MISSION 11 STRUCTURE SIZE

Some measure of your Mission 11 Structure needs to be at least as long as a four-stud LEGO element.

### RG03 - ELEVATOR SETUP

The correct setup position for the Elevator is with the Blue Car UP, as shown here:



### RG02 - DRONE SHAPE AND SETUP (Clarified - Improved Building Instructions are available)

Per original Update RG02, the correct way to build the Drone is shown below, and now the Building Instructions have been revised to show this.

The correct way to place the Drone on the Mat is on its square mark, with the Loop parallel over its line marks (the open Loop faces the Launch Area).



### RG01 - MAT PLACEMENT AND SETUP (Revised to correct the width of Home)

When placing your Field on an Official Table, slide the Mat gently until it meets up against the South and East Border Walls. When Table size and Mat placement are correct, Home will measure about 45" by 13-1/2" (1143mm by 342mm).



To hold the Mat in place, you may use a thin strip of black tape on the West edge as needed. Where the tape sticks to the Mat, it may cover the Mat's black border only.

---